

Article number: 204050M825A3X

Description: E+G levelling foot
GN 40-50-M8-25-A3-X

Note: X With female thread, External hexagon

Measures

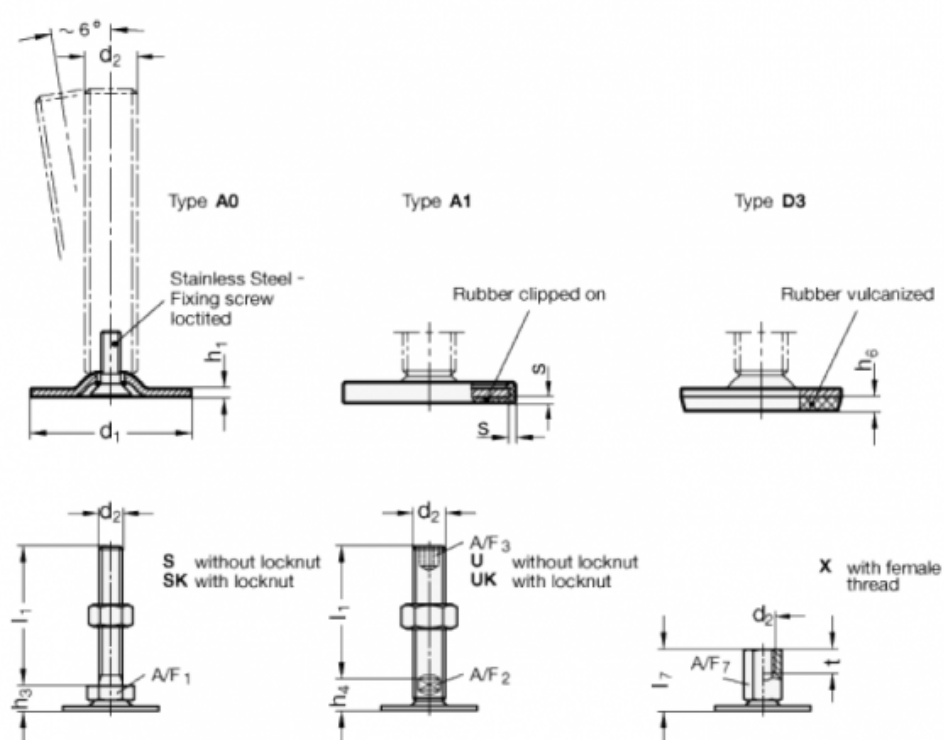

A/F7	= 14
d1	= 50
d2	= M8
h1	= 2.5
h6	= 4
l7	= 25
s	=
t	= 8